

REVISED 12-2016; ADDED CURTAIN WALL CLASS 20 EXCAVATION DETAIL. ENGLISH DESIGN/REPUBLIC/VEHICLE SIGNS - TRH 30-5-12 - THIS SHEET ISSUED 04-12

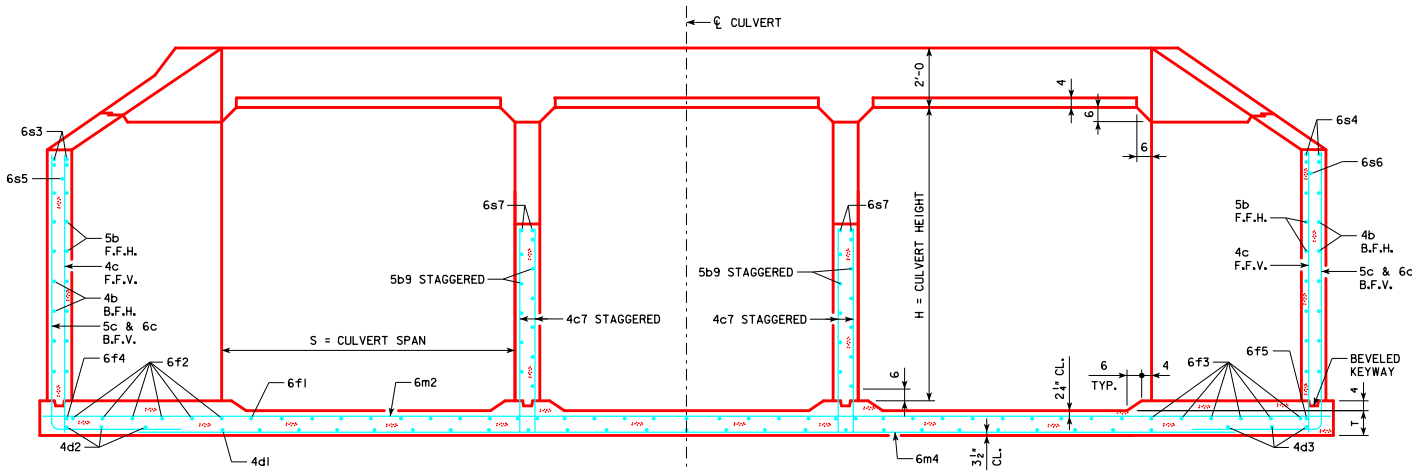

TYPICAL SECTION - NEAR CENTER OF APRON

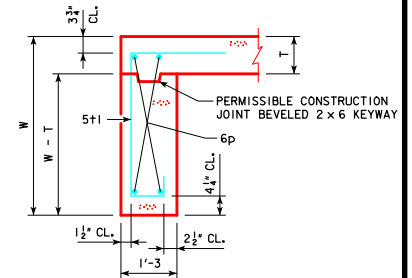

SECTION THRU CURTAIN WALL

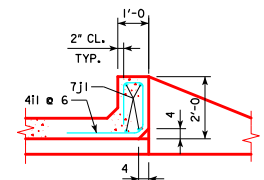

SECTION THRU PARAPET

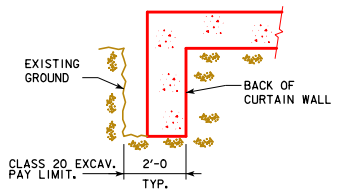

CURTAIN WALL CLASS 20 EXCAVATION

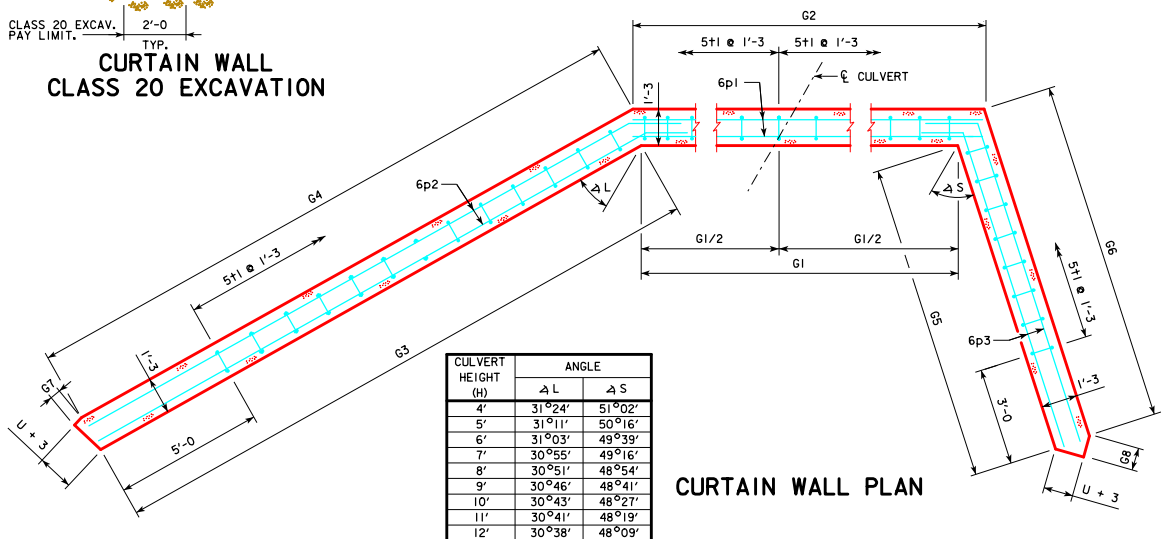

CURTAIN WALL PLAN

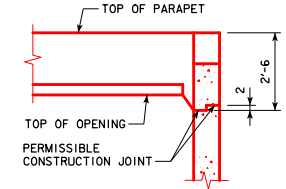

TOP OF WINGWALL DETAILS

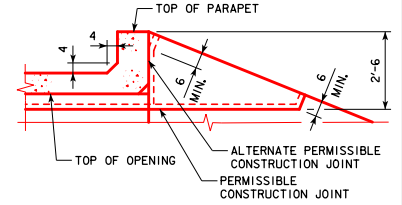

NOTES:

1. SEE SHEET TRRB G1-12 FOR GENERAL INFORMATION, SPECIFICATIONS, AND DESIGN STRESSES.
2. FOR DIMENSION TABLE SEE SHEET TRH 30-2-12.

12-2016 LATEST REVISION DATE  <i>Thomas E. McQuill</i> APPROVED BY BRIDGE ENGINEER	
	STANDARD DESIGN <b>TRIPLE REINFORCED CONCRETE BOX CULVERTS</b> APRIL, 2012
	<b>FLARED WING HEADWALLS</b> 30° SKEW

TRH 30-5-12